

30min

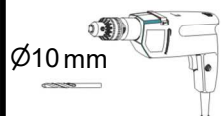

| A | B | C (mm) | | D |
|---|-----------|--------|-----|-----|
| 1 | S378-3015 | 1439 | 184 | 1/1 |
| 2 | S378-4005 | 1439 | 298 | 1/1 |
| 3 | S378-5018 | 300 | 1/1 | |

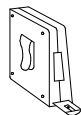
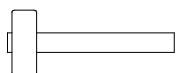
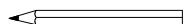
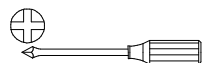
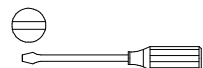
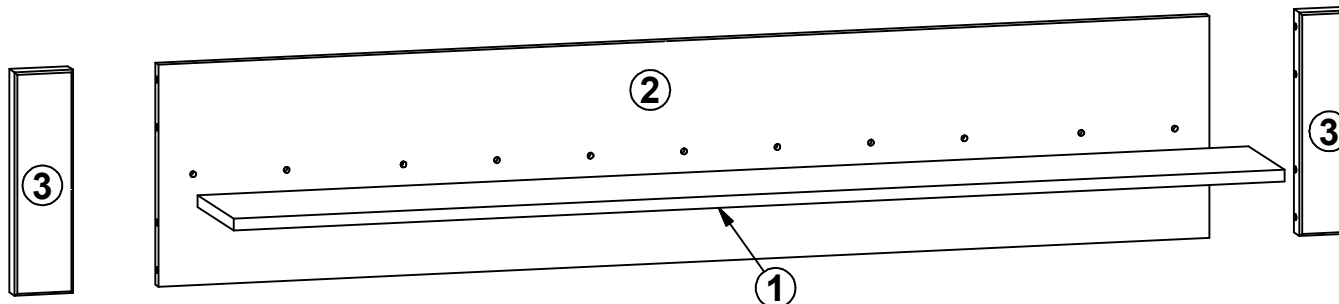

- 6x

Ø7x70 mm e27
- 6x

Ø5x11 mm e4
- 9x

Ø8x30 mm f1
- 3x

Ø10x50 mm f35
- 3x

g2
- 6x

silikon o21
- 3x

Ø6x60 mm p75
- 8x

Ø15x12 mm #16 r1
- 4x

40 mm r51
- 1x

4 mm z1

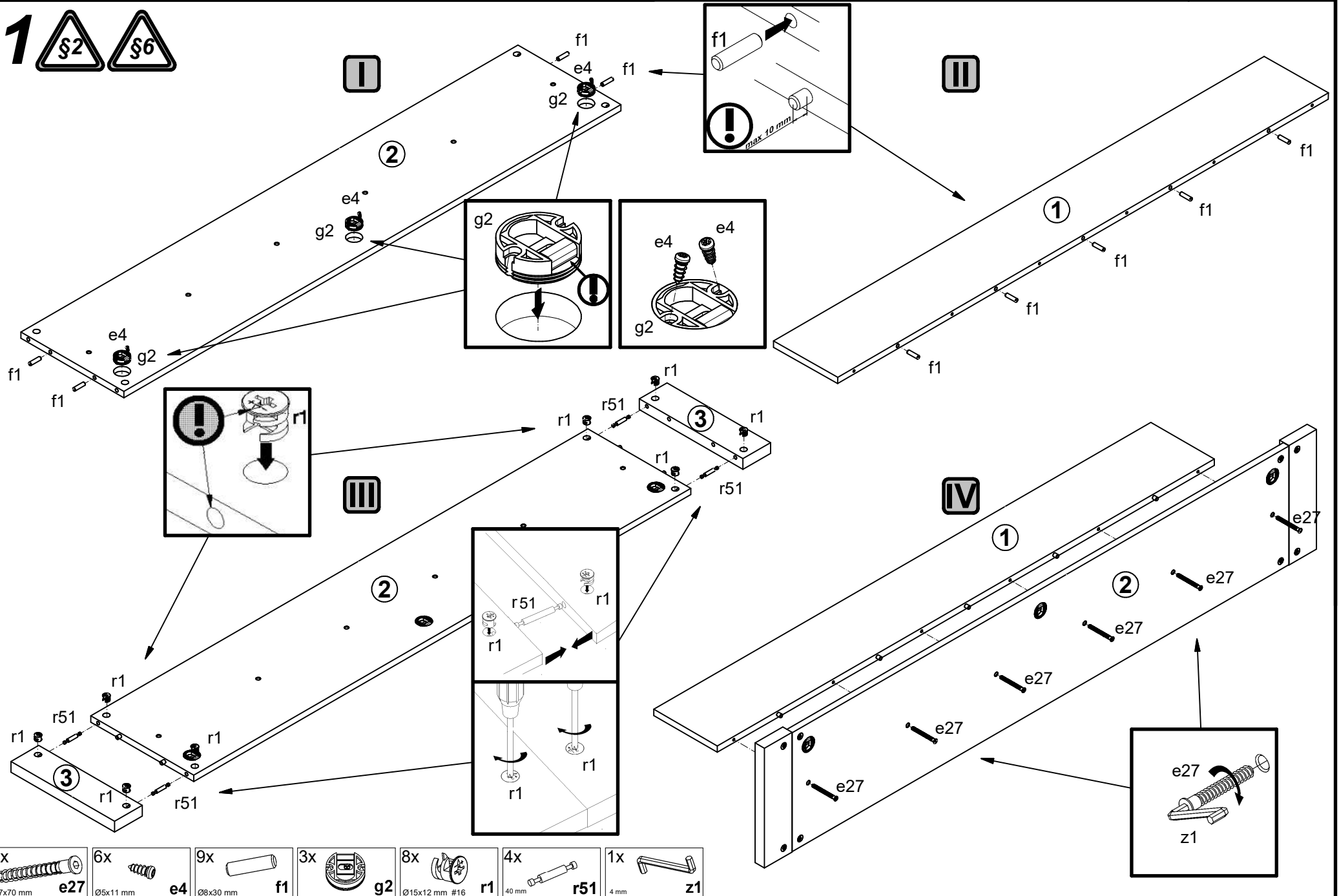

- 6x e27
- 6x e4
- 9x f1
- 3x g2
- 8x r1
- 4x r51
- 1x z1

2

